



ngd

**Automotiv  
Gears Spare Parts**



**Agricultural Machines  
Gears Spare Parts**



**Machine  
Industry  
Gears  
Spare Parts**



**Heavy Vehicles  
Gears Spare Parts**



**Speacial Gearbox  
Spare Parts**

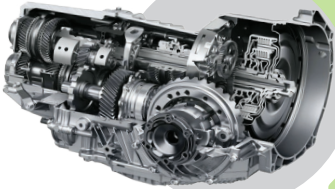



Nazsan Group Ltd. was founded to provide gear and spare part solutions for both Turkish domestic and worldwide customers with 30 years of experience in machining sector. With a production portfolio of CNC lathes, CNC work centres, gear grinding lathes, exacerbation, fellow teeth grinder, CNC grinding lathe, cut-off corner, half concave milling cutter and raw material cutting lathes. The production is supported by CAD design and computer aided manufacturing which gives us a production capability and flexibility for a wide range of products. The quality is controlled in each level from sourcing to pre-shipment in our measuring desks.





### QUALITY

We comply with national and international standards, developing technological conditions and customer demands.

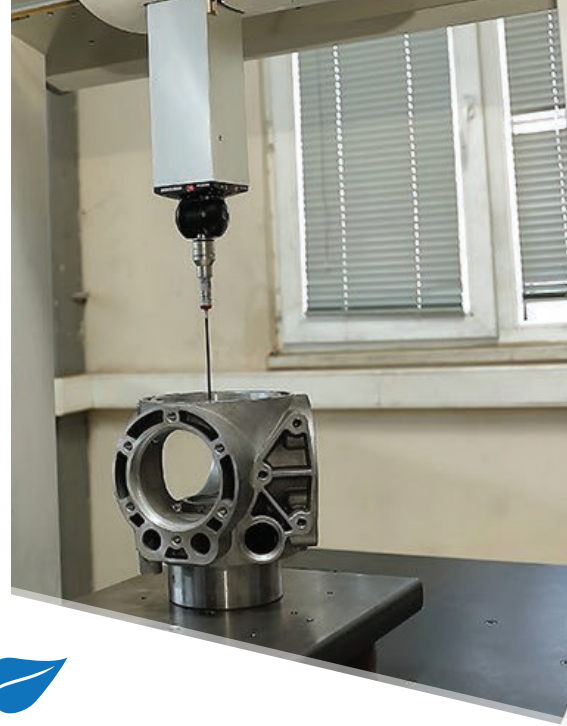

### SUSTAINABILITY

For a sustainable and more livable world, we are shaping all our production processes on the basis of sustainability.



### TEAM SPIRIT

With our strong technical team, we work without sacrificing quality in an innovative, dynamic, productive team spirit.



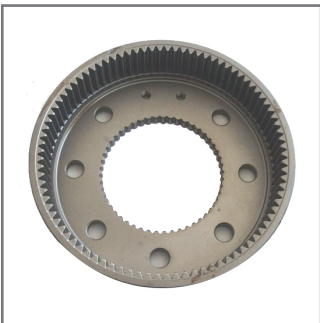
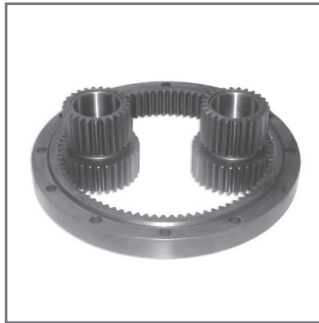
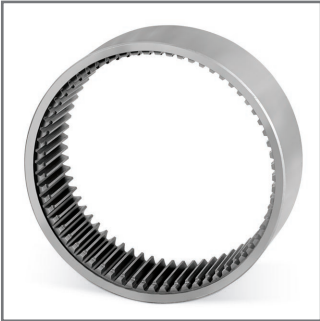

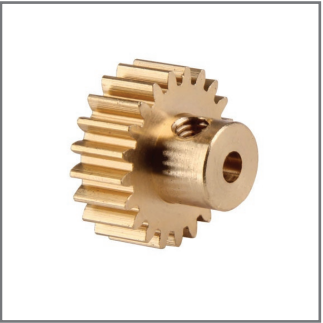
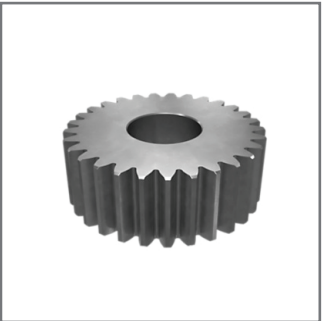

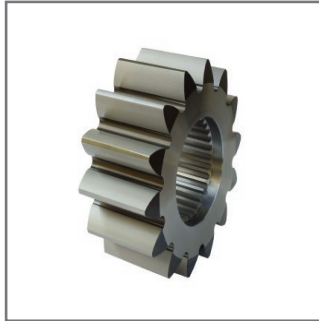





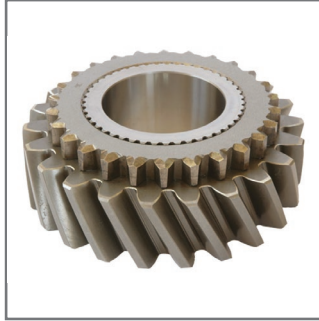

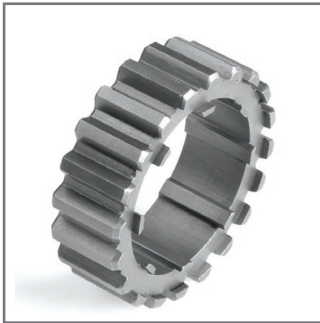
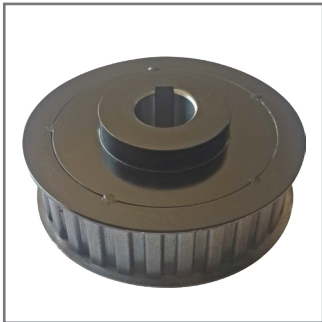
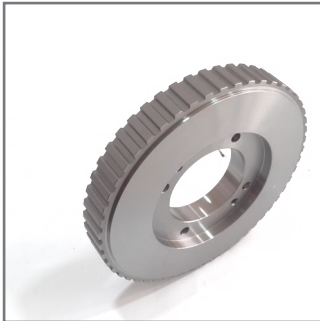



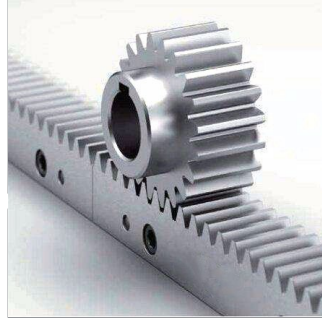

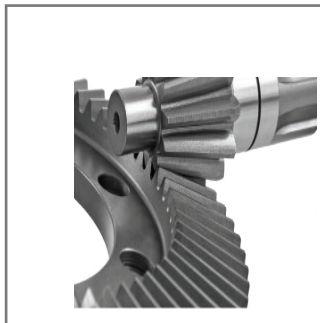
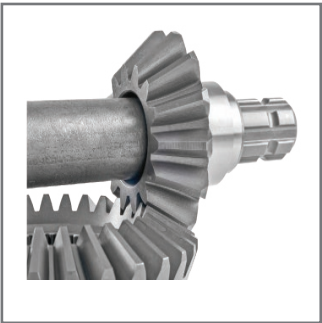

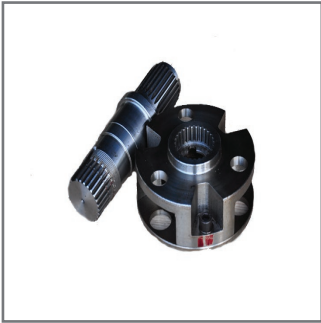
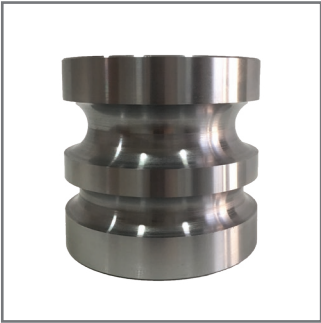
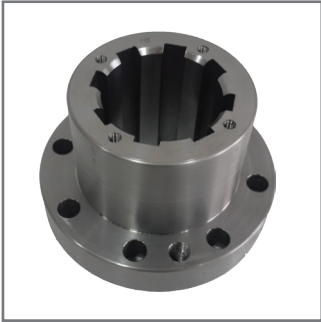
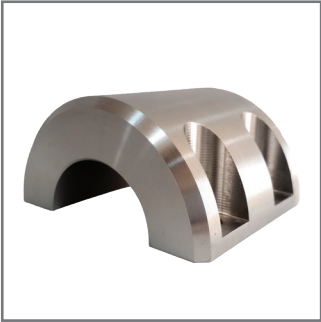
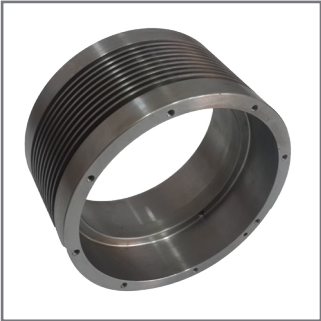
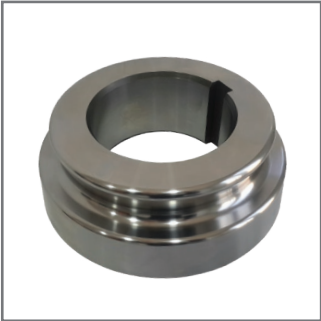
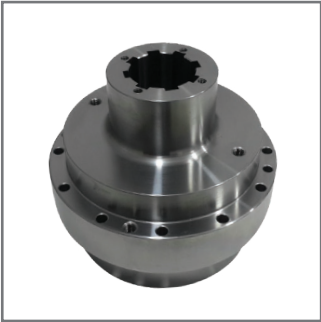



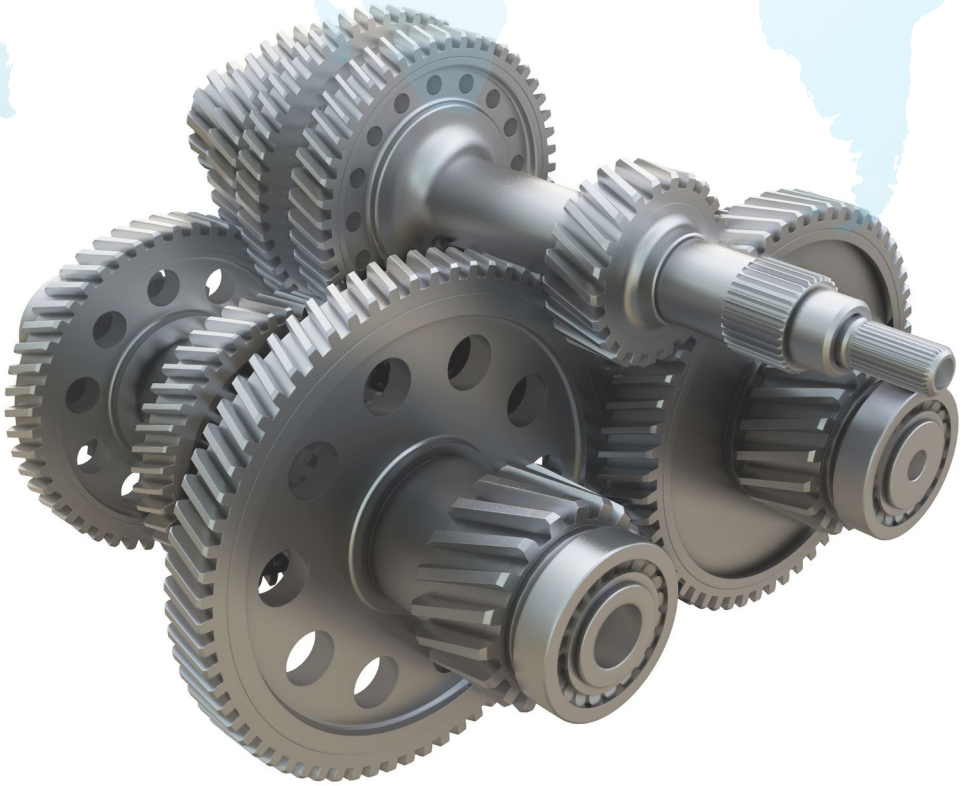

**NAZSAN GROUP DIŐ TİCARET VE DANIŐMANLIK TİC.LTD.ŐTİ.**

Yeni Sanayi Mah.589 Sok No:1C Nazilli / Aydın / TURKEY

**T:**+90 256 313 10 21 **M:** +90 543 311 71 57

**info@nazsangroup.com - www.nazsangroup.com**